

# Manitowoc Crane Group

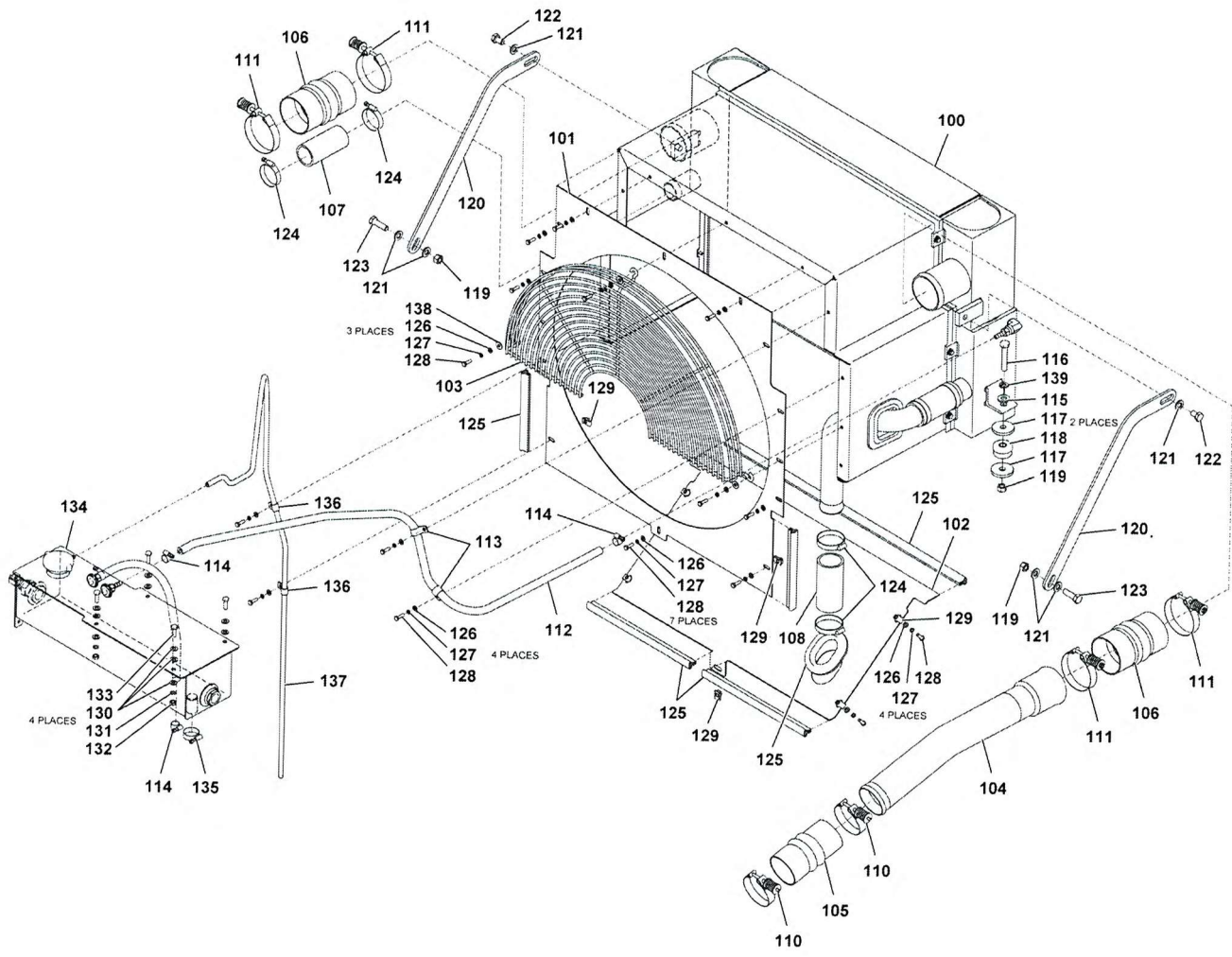

2159810146

(SHEET 1 OF 1)

Page 428